

幼女と少女 in 守矢





幼女と少女 in 守矢



な

で。

なんとも……

可愛らしく
なっちゃった
わね

そーあえす
服どうしようか。

私の着る？

どうしたの？

ん……

いえあの
神社で……



あの子が
白黒の子が
来てねー

あの子
変な魔法
好きじゃない

それで
ちよつと……

よし
よし。

ほら。

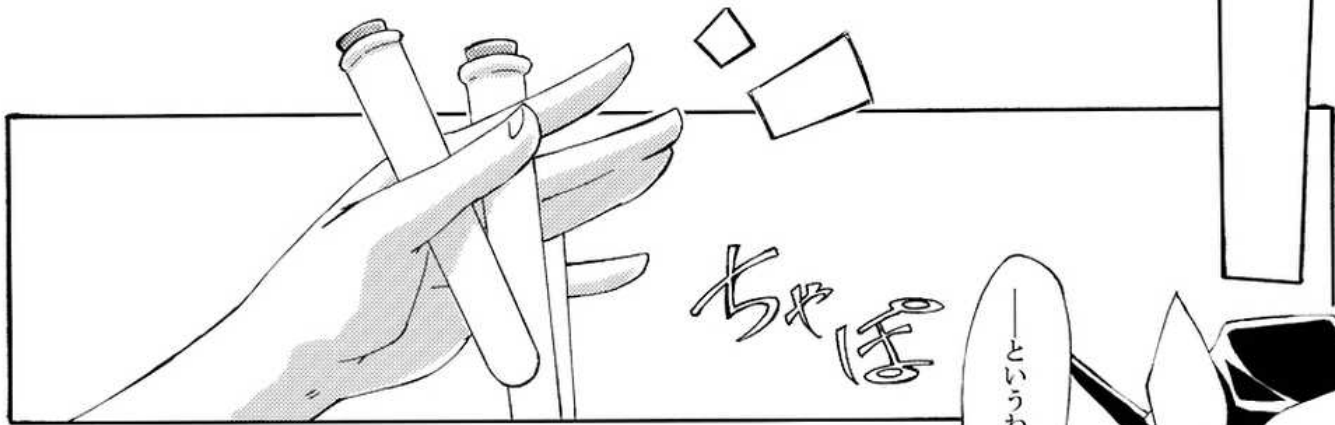

—というわけで
これだ



今日はこれの
実験に来たんだ
何せ、今、

背が伸び縮み
する薬
に。

……何ソレ？

また
いそなり
来！…



……私以外に
しなさいよね

おあつらえ
向きに色々
居るから

わ私は
お断り
しますよ!!

面白そう
じゃない

も
洩矢様!?

あ……

あいにく

なっ

カク

私には
知らない
わよ

ほら



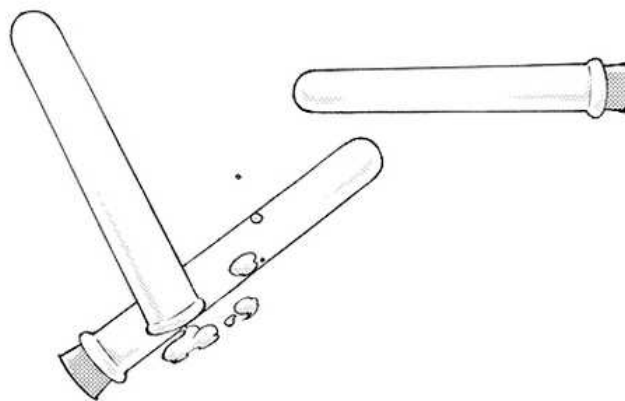

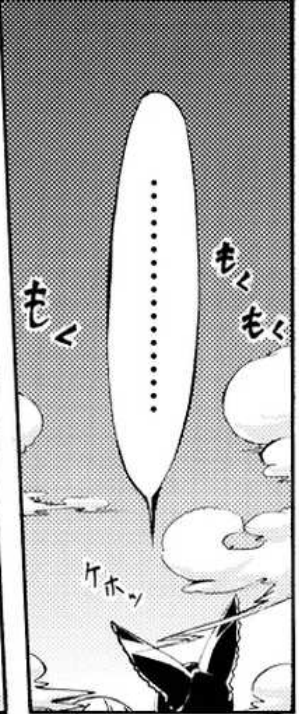

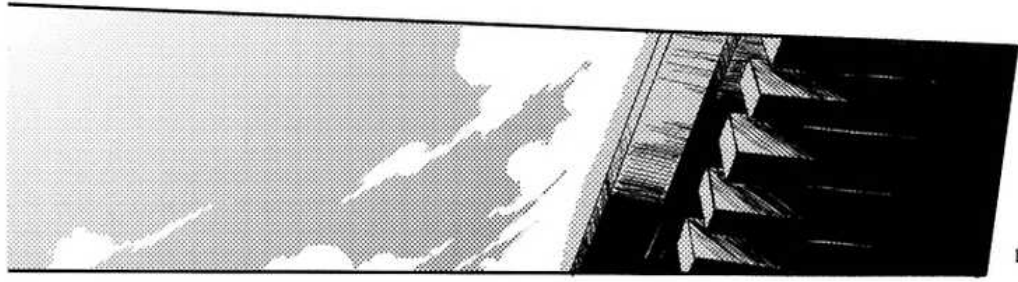

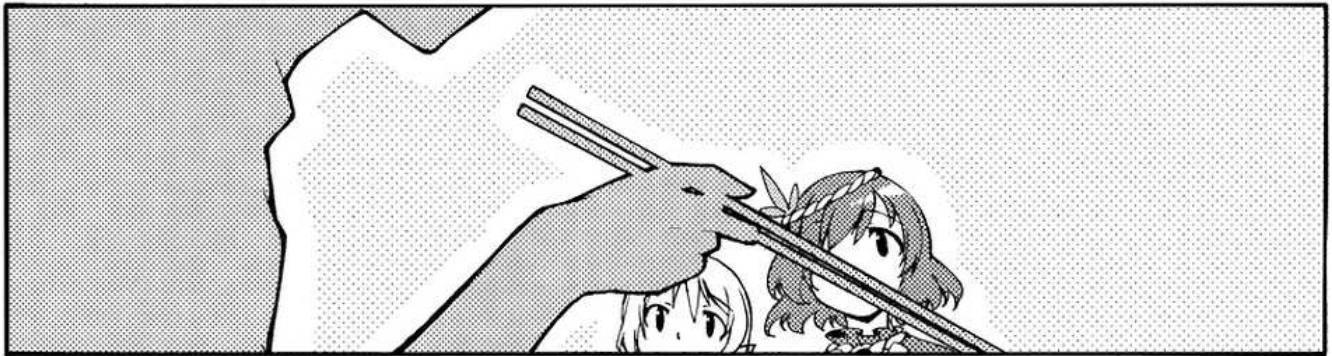
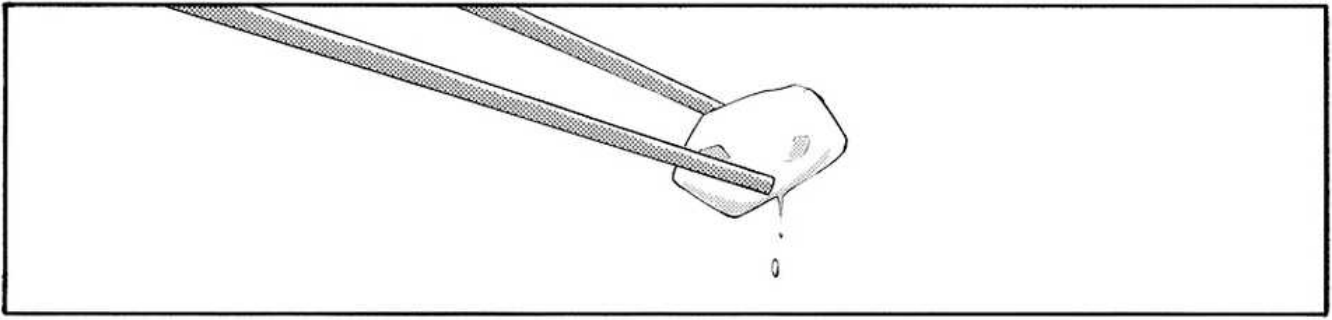

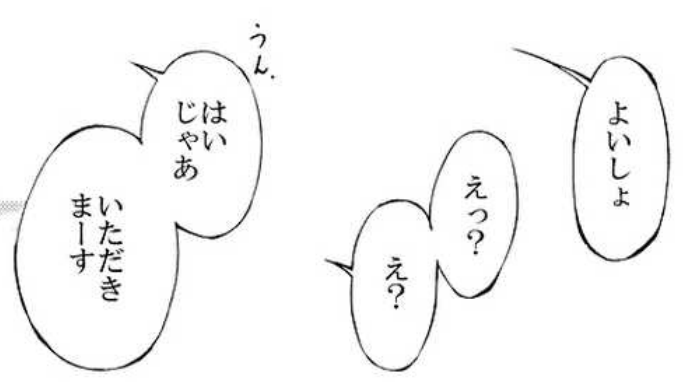



ん?
眠い?

ふあ……

お昼寝でも
しよつか

お暇いばいに
なつたもん



うん



……?
八坂様



はいよー

?

ちよつと遊んでくるわ

諏訪子

早苗を
お願いね

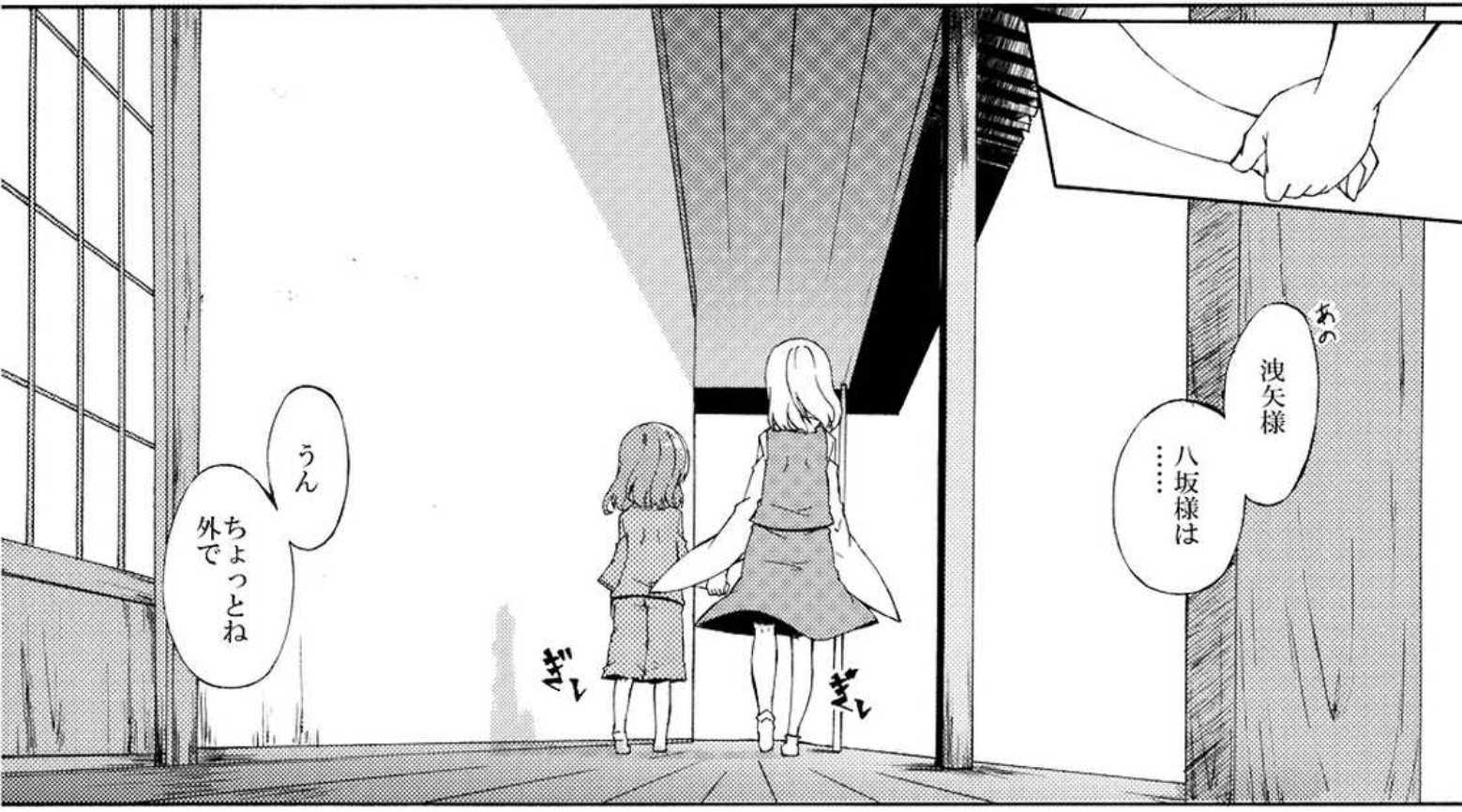

外で
ちよつとね

うん

……
八坂様は

あの
洩矢様



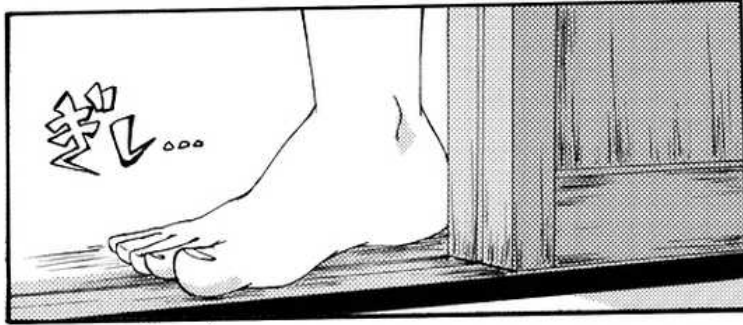

どこぞの
鴉とでも

遊んでるんじや
ないかな

——早苗



あ神奈子
早かったね

新聞屋は
どうだった

うん

今頃は
巫女か白黒の
とこにでも
行ってんじや
ないかしら



あっさり
退いたわよ

ま今回は
他にも良い
取材対象が
居るしねえ……



ペたん







風祝としても
優秀だったもの

私たちも
この子は大丈夫
なんだって

そういうこと
気に留めて
なかった

……うん



こうして一緒に
寝てあげた
覚えも



……ん



早苗が
元に戻っても

こんな風
に寝たり
するの

—遅くない
かな？



……
今からでも
遅くない
かな？
ポツ……



じゃ
 私たちも
 寝ちやいま
 しょうか
 仲良くね

うん
 丁度ねむく
 なってきた
 わー

むん
 ……お休み
 諏訪子

おやすみー

せ、せ、せ

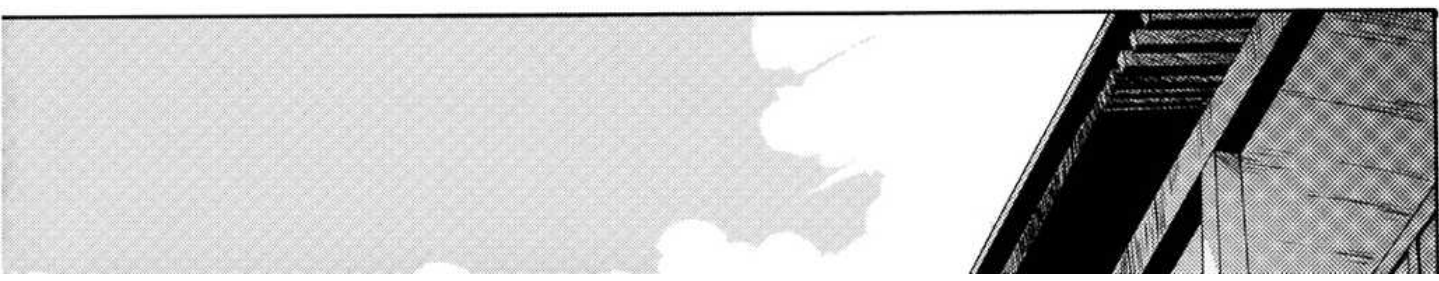
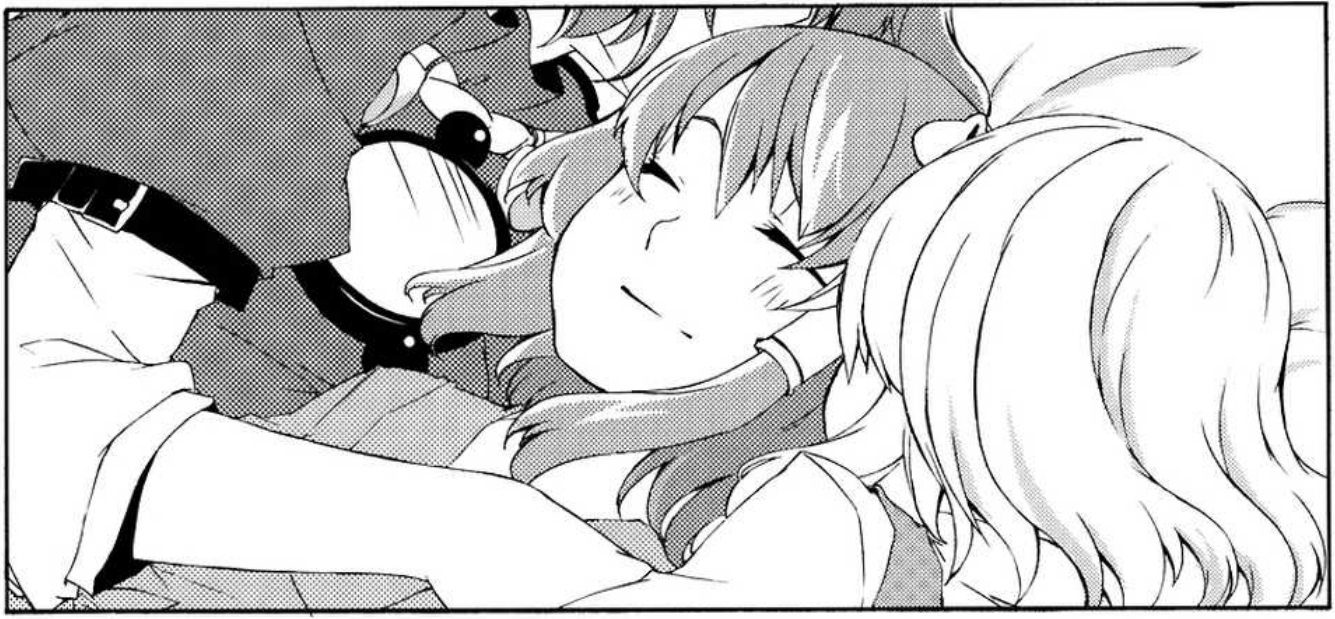

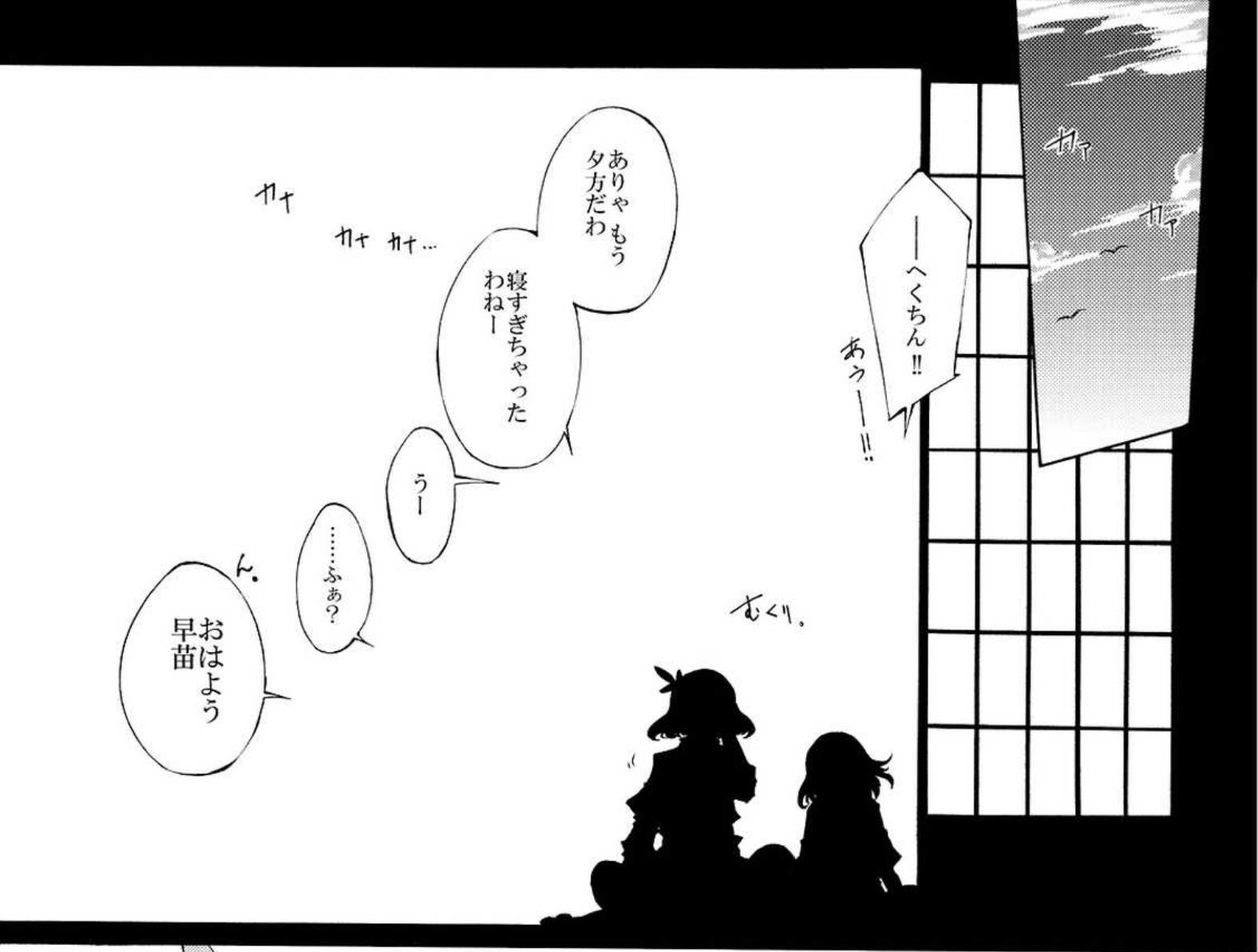

発行元：(PC)<http://percol.blog.shinobi.jp/>

発行日：08/06/15

印刷所：ねこのしっぽ